

K75 Plate

Lat Pull Down Attachment

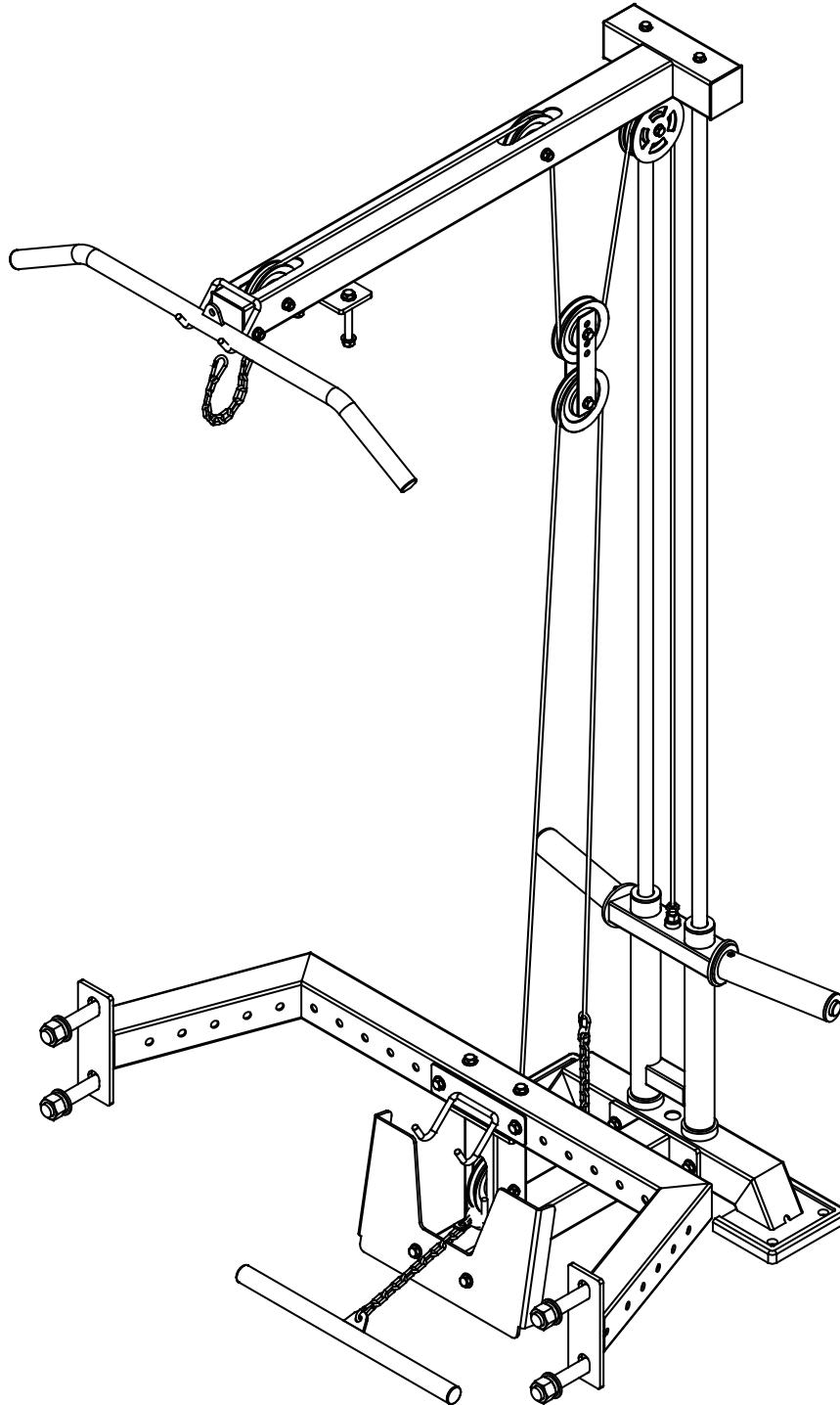

! CAUTION
Read all precautions
and instructions in this
manual before using this equipment

K I N T A®

※※※Please read operation manual carefully※※※

1. Please keep the box and the manual after installing the machine.
2. Check the stability of the bolts regularly.
3. Please install the machine in a commodious place.
4. Put the machine on the level ground, and use a mat to protect the floor.
5. Please consult to your doctor, physician before using any exercise equipments.
6. There are slip proof cover on the nut (little nylon circle on the nut); please tighten them with wrench.
7. Please tighten the screws; otherwise it might be dangerous to use.
8. Please do not alter the machine in any way it might be dangerous to change and mend the machine.
9. Store in the place where is away from moisture, salt (near Pool) high temperature and under sun.
10. For maintenance and cleaning exercise machines Please clean the dirt with detergent scour, using dry rag and clean water (do not use gas, dilution and other chemicals).
11. Do not put your hands in the moving part of the machine when you are doing exercise.

Thank you for choosing our Fitness products, We hope you enjoy using and you get maximum benefit of it.

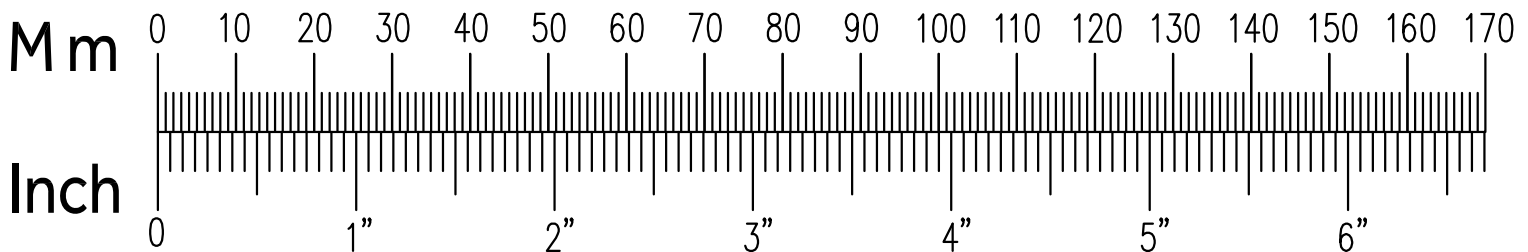

PART LIST

1

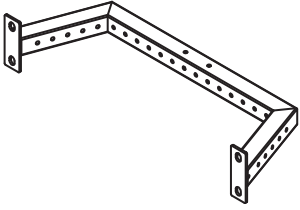

2

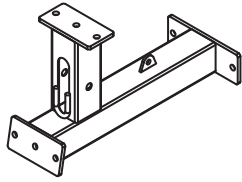

3

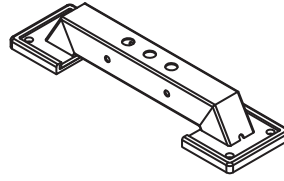

4

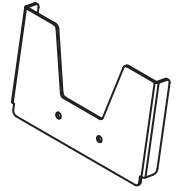

5

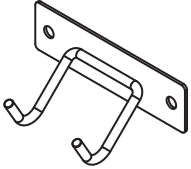

6

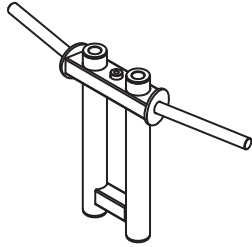

7

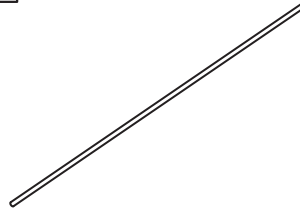

8

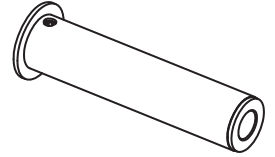

9

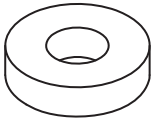

10

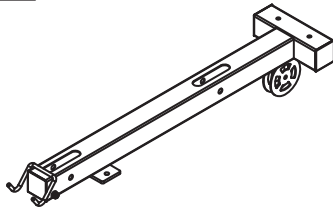

11



12



13



14

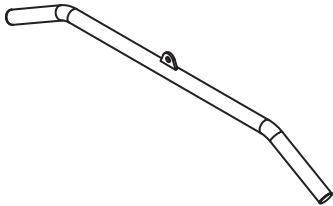

15

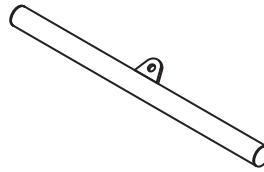

16

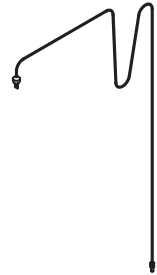

17



PART LIST

18



19

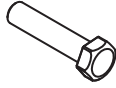

20

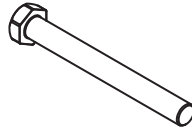

21



22

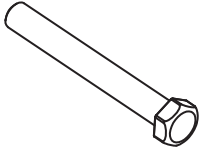

23

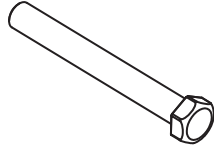

24

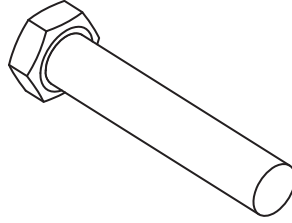

25



26



27

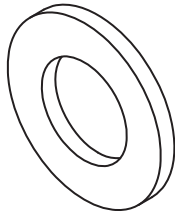

28

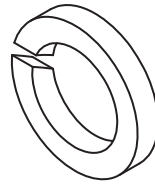

29



30

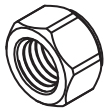

31

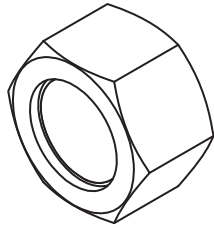

32

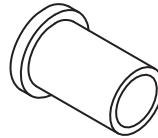





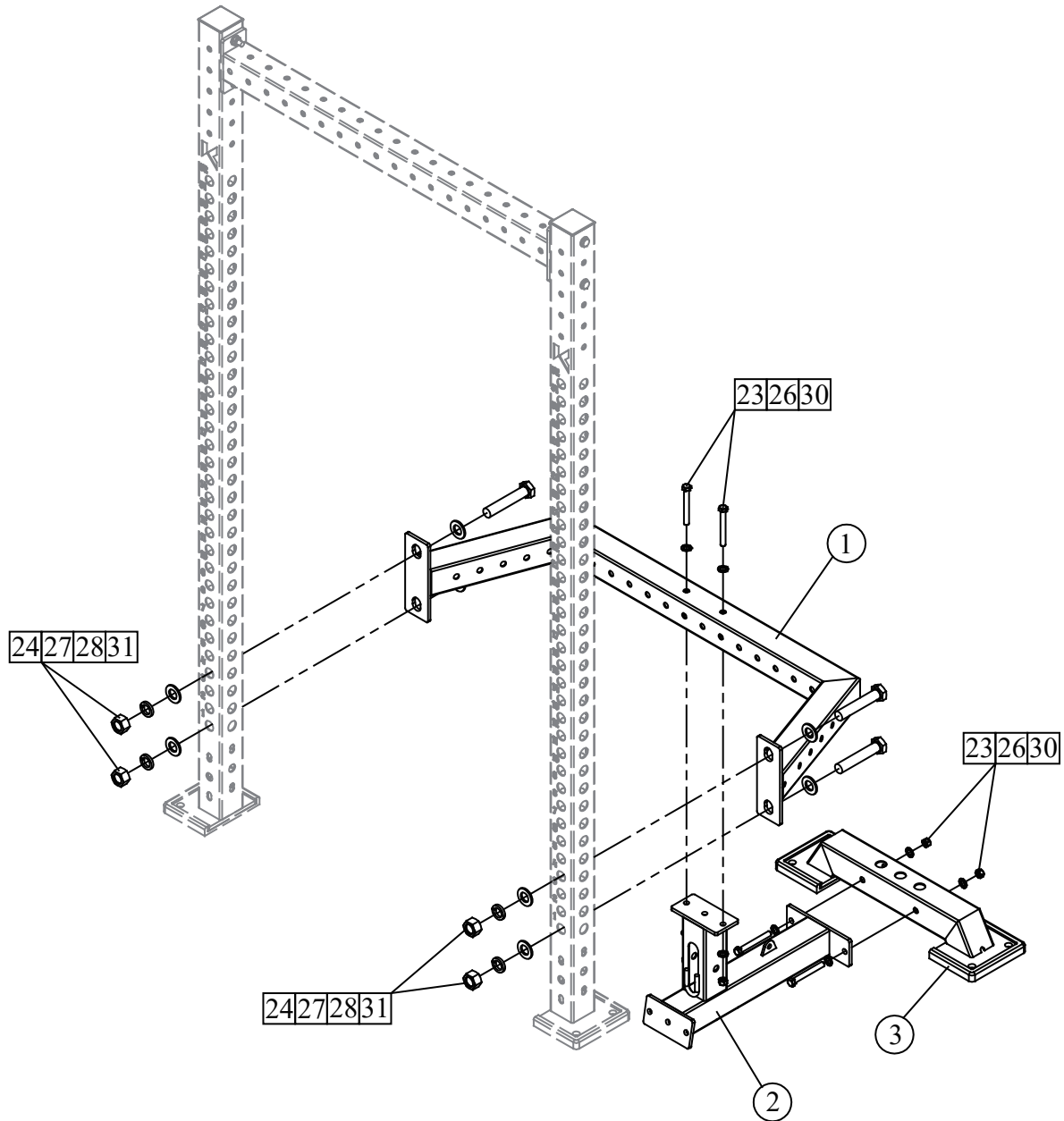

PART LIST

NO.	DESCRIPTION	QTY
1	Connection Tube	1
2	Base Tube	1
3	Bottom Tube	1
4	Foot Step	1
5	Connection Plate	1
6	Weight Plate Frame	1
7	Guide Rod	2
8	OB Tube	2
9	Rubber Pad	2
10	Top Connecting Tube	1
11	Adjustable Pulley Plate	2
12	Pulley	6
13	Pothead	3
14	Lat Bar	1
15	Pull Up Bar	1
16	Cable:3580mm	1
17	Cable:3020mm	1
18	Bolt M10*20	4
19	Bolt M10*45	3
20	Bolt M10*90	3
21	Bolt M12*30	2
22	Bolt M12*95	2
23	Bolt M12*100	6
24	Bolt M24*120	4
25	Washer Φ 10	10
26	Washer Φ 12	20
27	Washer Φ 24	8
28	M24 Spring Washer	2
29	Lock Nut M10	6
30	Lock Nut M12	10
31	Lock Nut M24	4
32	Bushing	6

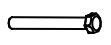
Installation Instruction

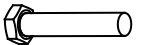
Step 1





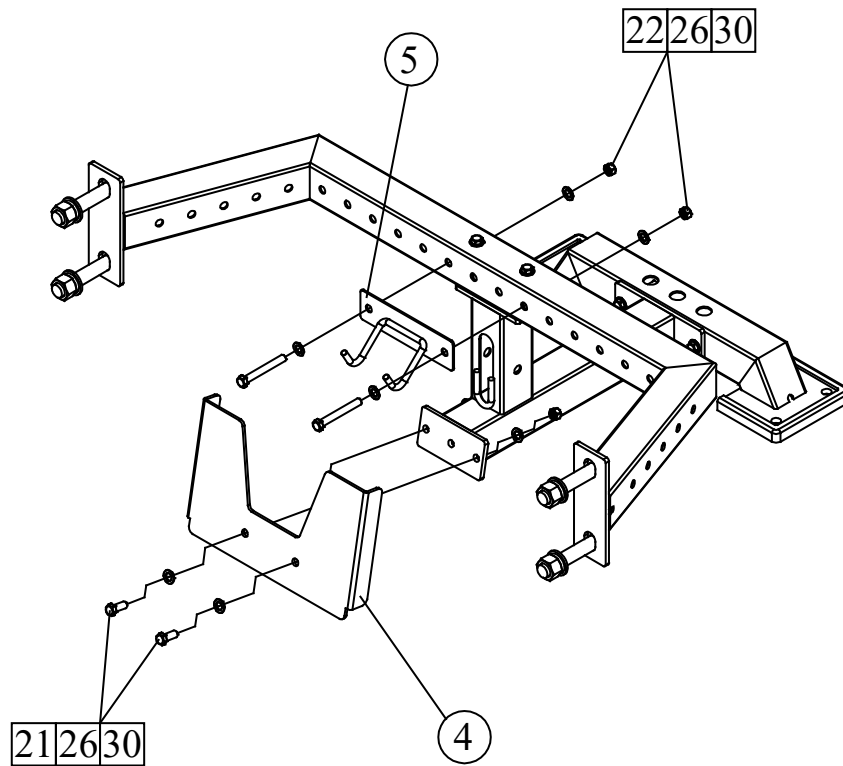

23#		M12*100	Qty:4	26#		12	Qty:8
24#		M24*120	Qty:4	27#		24	Qty:8
				28#		Spring 24	Qty:2
				30#		M12	Qty:4
				31#		M24	Qty:4

Installation Instruction

Step 2

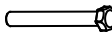



21#		M12*30	Qty:2	26#		12	Qty:8
22#		M12*95	Qty:2	30#		M12	Qty:4

Installation Instruction

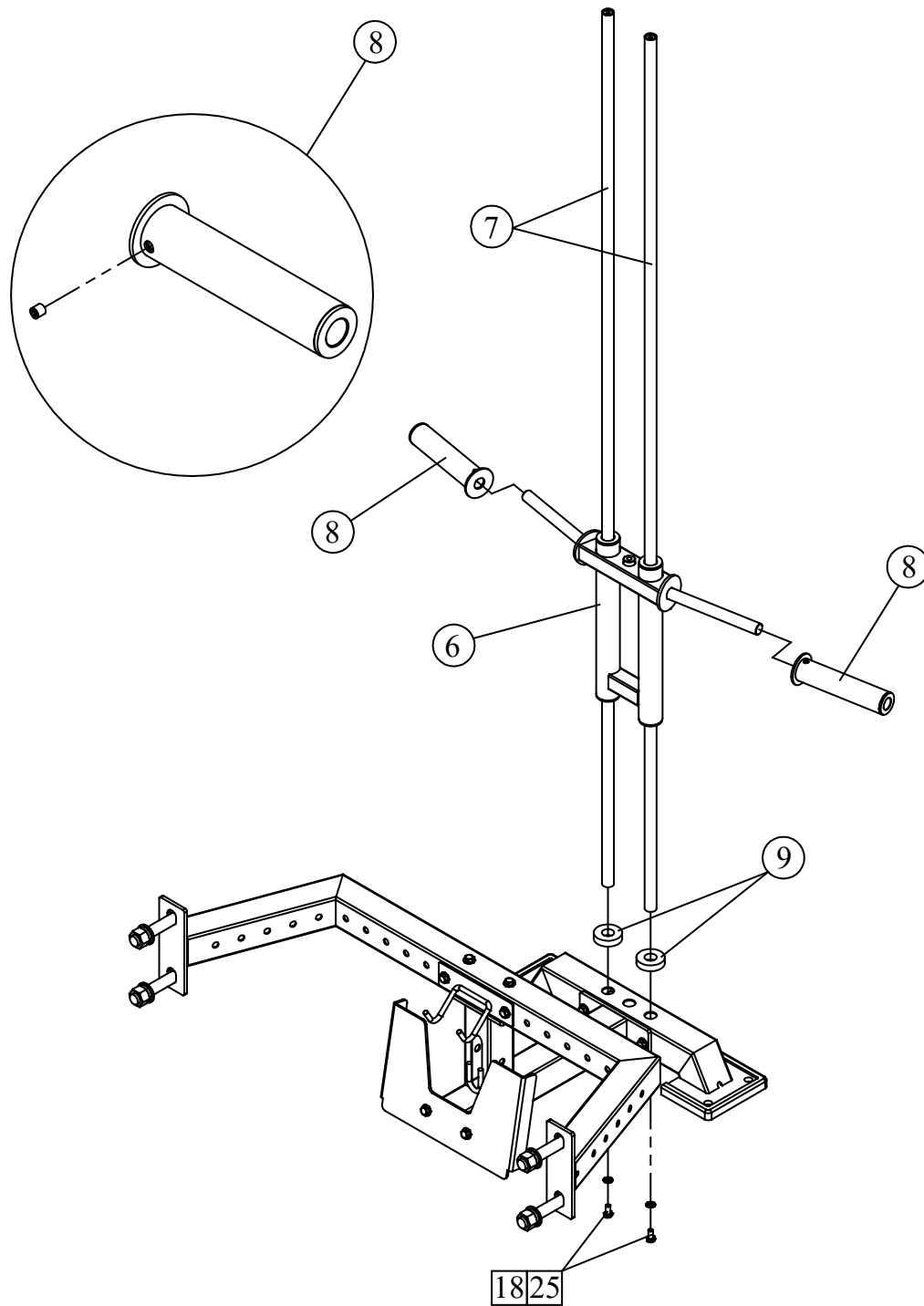
Step 3





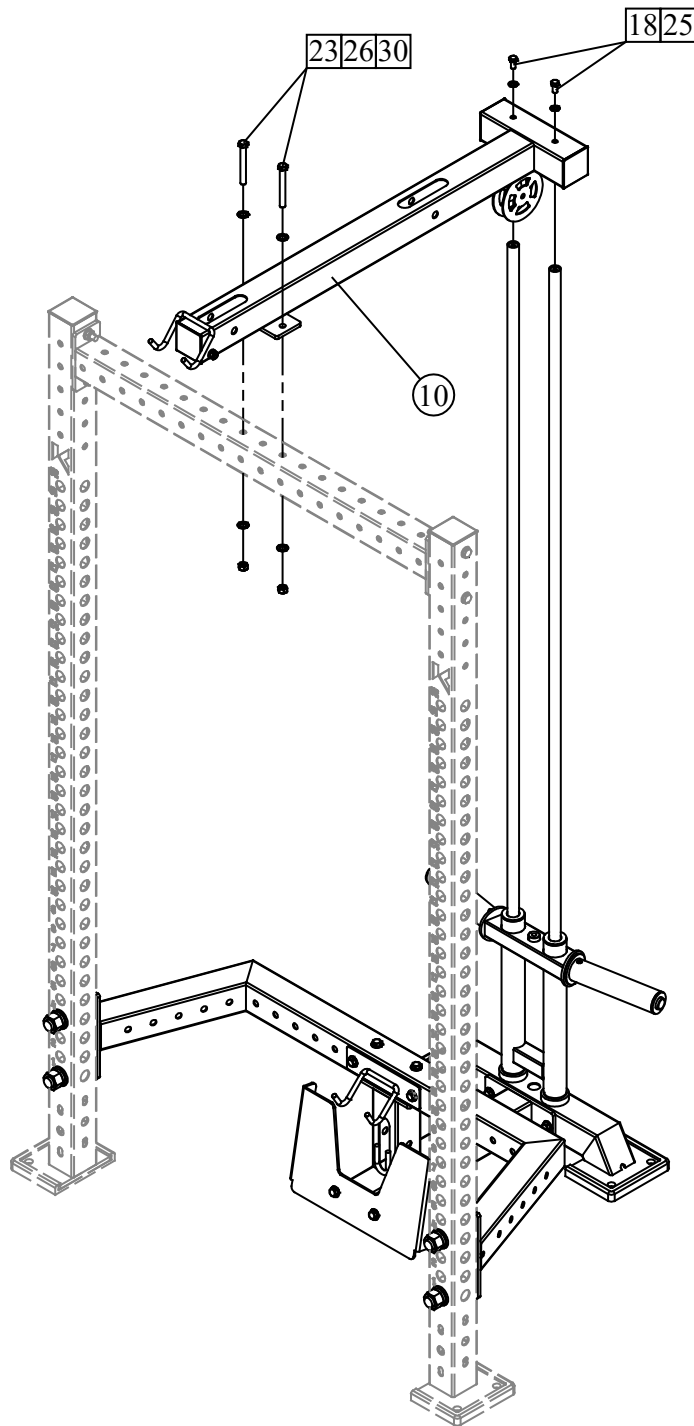

18#		M10*20	Qty:2
25#		10	Qty:2

Installation Instruction

Step 4





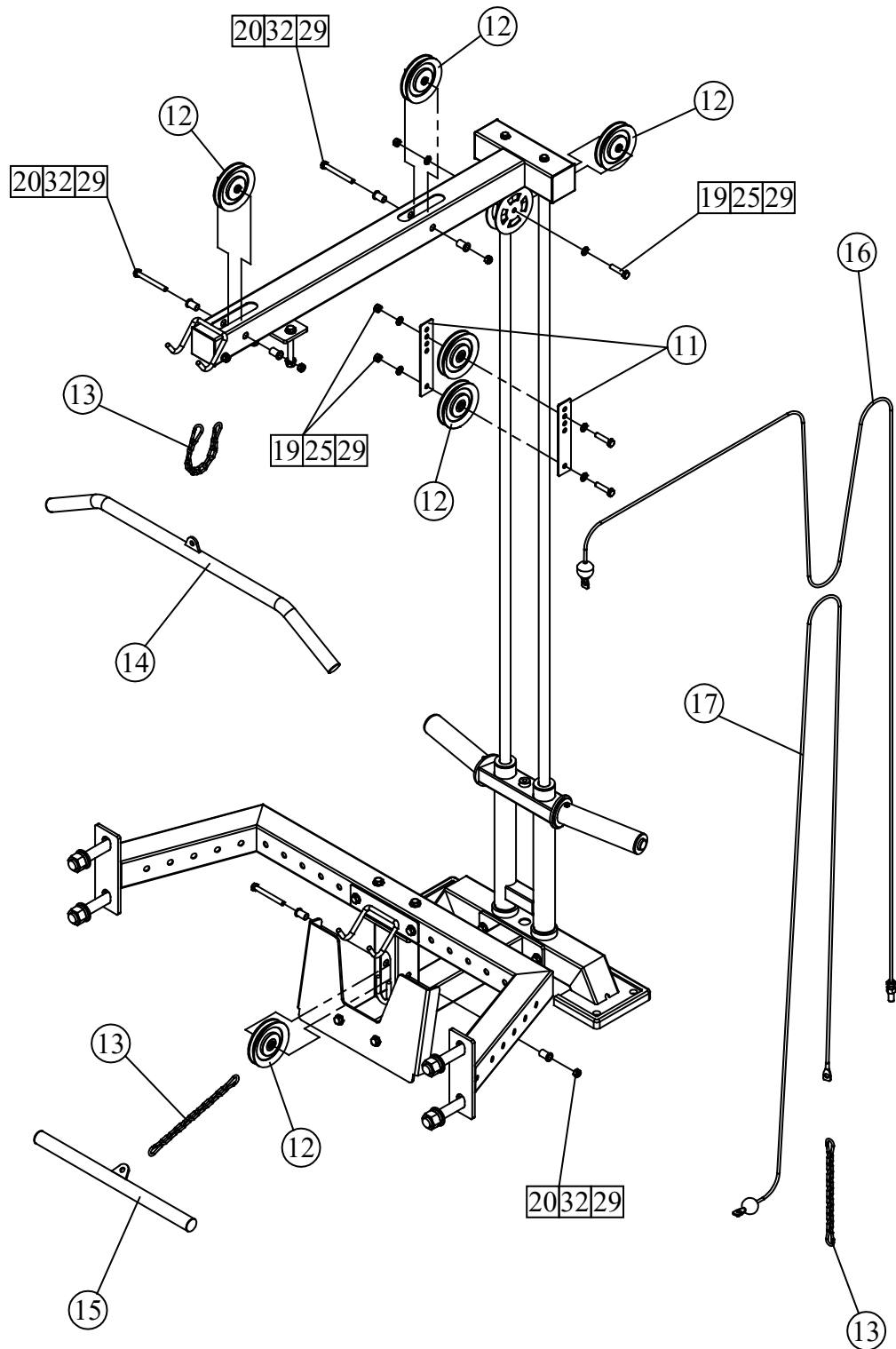

18#		M10*20	Qty:2	25#		10	Qty:2
23#		M12*100	Qty:2	26#		12	Qty:4
				30#		M12	Qty:2

Installation Instruction

Step 5



19#		M10*45	Qty:3	25#		10	Qty:6
20#		M10*90	Qty:3	29#		M10	Qty:6

Installation Instruction

Step 5

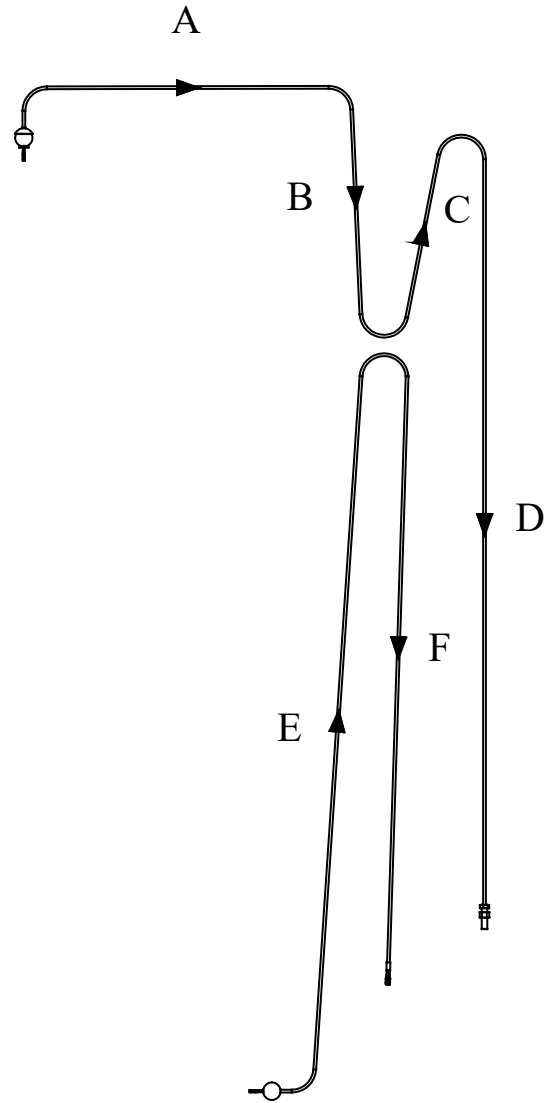
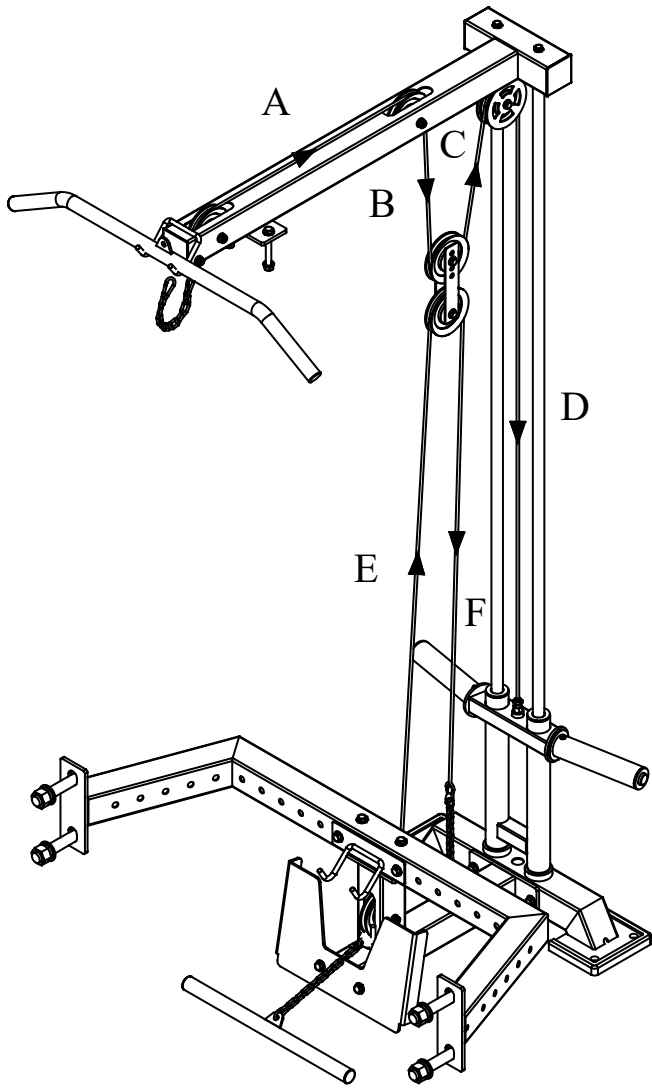

A → B → C → D

E → F